

# **High Tech Methods to Reduce Concentrate Volume Prior to Disposal**

by:

**Anthony Tarquin<sup>1</sup>**

**March 8, 2010**

<sup>1</sup>Department of Civil Engineering, University of Texas at El Paso

## **Table of Contents**

	<b><u>Page</u></b>
Executive Summary -----	4
Introduction-----	5
Background-----	5
Concentrate Characterization-----	6
Membrane Fouling Considerations-----	7
Lime Treatment Laboratory Studies-----	9
VSEP Pilot Plant Studies-----	11
Description of VSEP Technology-----	11
VSEP Test Procedure-----	14
VSEP Test Results-----	15
Seawater RO Pilot Plant Studies-----	17
Initial SWRO Studies with Single-Membrane Unit-----	18
Fully Automated Seawater RO System-----	22
Other Considerations-----	23
Effect of pH on Recovery-----	23
Antiscalant and Acid Evaluation-----	24
Feed Water Temperature vs. Capital Cost-----	26
Economic Considerations-----	26
Conclusions-----	29
Recommendations-----	30
References-----	31
Appendix A-----	32
Acknowledgements-----	34

## List of Figures

<u>Figure</u>	<u>Page</u>
1. Location of Well 72 and Other Feed Wells-----	6
2. Comparison of Concentrates from Pilot Plant Site and KBH Plant-----	7
3. Laboratory Test Set-up for Conducting Lime Treatment Studies-----	9
4. KBH Results Plotted with Pilot Plant Results-----	10
5. KBH Results Adjusted to Alkalinity of 380 mg/L-----	11
6. VSEP Pilot Test Unit - Single Membrane-----	12
7. Schematic of VSEP Drive System (from New Logic Website)-----	13
8. Schematic of Effect of Shear at Membrane Surface (from New Logic Website)-----	13
9. VSEP Pilot Plant Test Set-up-----	14
10. VSEP Perm Flow and Concentrate Conductivity vs. Time-----	16
11. VSEP Permeate Flows with and without Precipitate at Start of Run-----	17
12. Small Seawater RO Unit Used for Conducting Initial Tests-----	18
13. Schematic of Seawater RO Test System-----	19
14. Perm Flow, Silica, and Feed Conductivity in Typical SWRO Run-----	20
15. Silica Concentration in the Feed Water of Nine Different SWRO Runs-----	20
16. Measured Silica Concentrations vs. Calculated Theoretical Concentrations---	21
17. Fully-Automated Batch Treatment Seawater RO System-----	22
18. Effect of pH on Water Recovery from RO Concentrate-----	24
19. Effect of Acids and Antiscalant on Calcium Sulfate Precipitation-----	25
20. SWRO Costs and Cash Flow vs. Water Recovery-----	28

## List of Tables

<u>Table</u>	<u>Page</u>
1. KBH Concentrate Characteristics-----	8
2. Lime Treatment Results for KBH Concentrate-----	10
3. Reactive Silica and Total Silicone (by ICP) as Silica, mg/L-----	21
4. Characteristics of Initial Feed, Permeate, and Final Concentrate-----	23
5. Values Used in Calculating Cost of Water Recovered From RO Concentrate--	27
6. Product Water Costs as a Function of Percent Recovery-----	29
Appendix A;	
A-1. VSEP Test Results with Antiscalant-----	32
A-2. VSEP Test Results with Precipitation at Start-----	33

## **List of Acronyms and Definitions**

Blending ratio	Total Volume/permeate volume
EDAX	Energy Dispersive X-ray Spectroscopy
Flux	Flow thru membrane in gallons per square foot per day
Foulant	Substance on membrane that causes reduced permeate flow
GFD	Gallons per square foot per day
ICP	Inductively coupled plasma
KBH	Kay Bailey Hutchison Desalting Plant
MGD	Million gallons per day
Reactive silica	Silica in monomeric form
% Recovery	Volume of permeate/volume of feed water
RO	Reverse Osmosis
SWRO	Seawater Reverse Osmosis
TDS	Total Dissolved Solids
Total Silica	Reactive silica and polymeric silica
VSEP	Vibratory Shear Enhanced Processing

# Executive Summary

(TWDB Contract #0704830769)

A problem faced by inland communities who undertake brackish water desalination (desalting) projects is the selection of an economical and environmentally acceptable disposal option for the concentrate that is generated in the process. The most common disposal option of surface water discharge to an ocean or brackish water bay is obviously not available to inland communities. Research funded by the U.S. Bureau of Reclamation and others indicated that it might be economically feasible to recover additional water from silica-saturated, reverse osmosis (RO) concentrate through lime treatment followed by second-pass RO, thereby possibly rendering evaporation and/or other options more viable. One task in this project involved laboratory testing of the lime treatment process (for silica removal) using the concentrate generated at El Paso Water Utilities' (EPWU's) Kay Bailey Hutchison (KBH) Desalting plant. The results confirmed previous findings that showed that lime is very effective at removing silica after the carbonate and bicarbonate alkalinity has been removed.

Another task in this project involved using vibratory shear enhanced processing (VSEP) technology and a batch-treatment seawater reverse osmosis (SWRO) system to recover additional water from the silica-saturated RO concentrate that is generated at the KBH desalting plant in El Paso, TX. The results showed that while VSEP technology could be used, the SWRO option was preferable from economic and operational points of view. By reducing the pH and using an antiscalant for calcium sulfate control, recoveries in the 85-90% range were achieved with the SWRO system without fouling the membranes. Reactive silica concentrations of over 1000 mg/L were measured in the concentrated concentrate.

Implementation of a full-scale SWRO system at the KBH plant would generate an additional four million gallons of water per day at a cost of less than \$1.87 per thousand gallons. At 85% recovery of concentrate, there would be net cash flow exceeding \$178,000 per year and the overall water recovery at the plant would increase to 97%.

## **Introduction**

This document is the final report of a project aimed at finding a cost-effective method for recovering additional water from silica-saturated reverse osmosis (RO) concentrate while at the same time reducing the concentrate volume requiring final disposal. The original project period was from September 2007 through September 2008, but one of the tasks was modified to include evaluation of a seawater RO system (SWRO), so the project period was extended through January 2009.

## **Background**

El Paso Water Utilities (EPWU), in partnership with Fort Bliss (a U.S. Army installation), owns and operates the largest inland brackish groundwater reverse osmosis (RO) desalting plant in the United States. The Kay Bailey Hutchison (KBH) Desalting Plant produces 27.5 million gallons of drinking water per day when operating at full capacity.

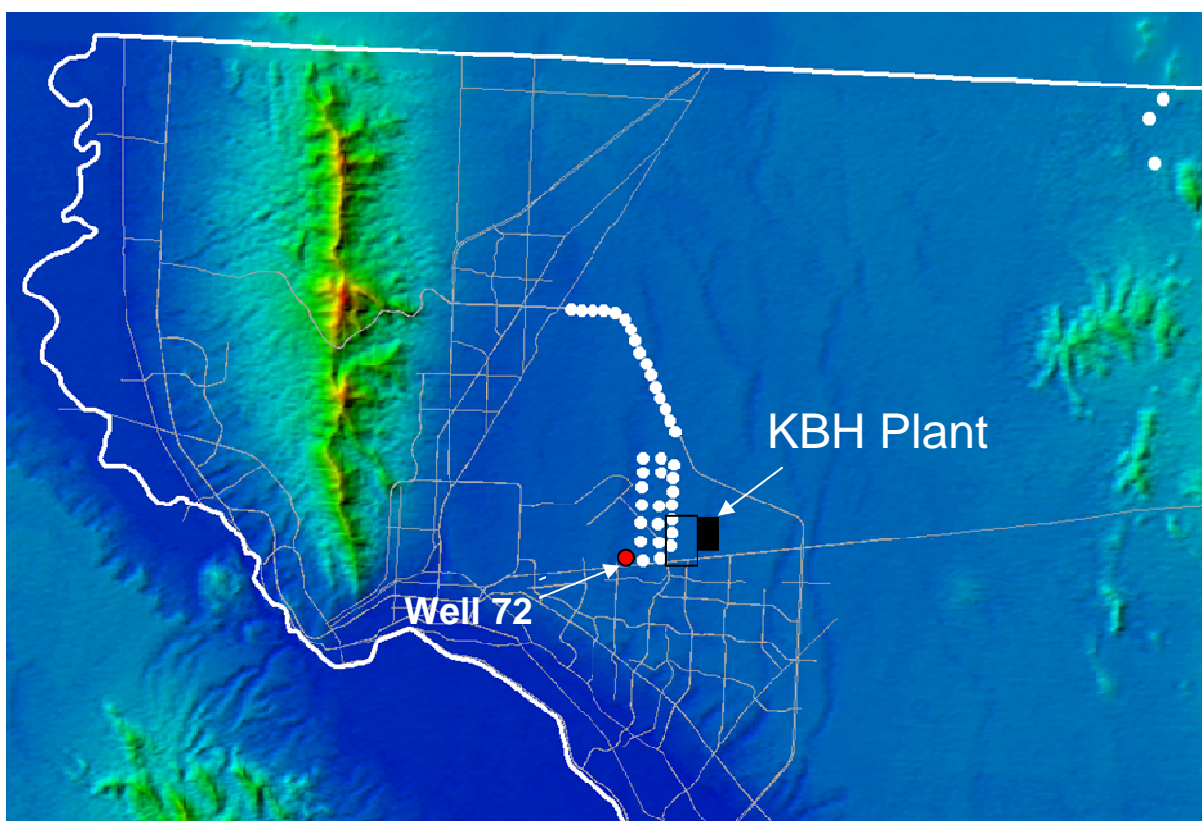
A problem faced by any inland water desalting facility is disposal of the brine solution (concentrate) that is generated in the reverse osmosis process. The problem is exacerbated when the raw water supply contains substances that could foul membranes when additional permeate is extracted from the concentrate flow stream to reduce the volume of concentrate going to disposal. This is the case in the city of El Paso, where the brackish groundwater contains silica at an average concentration of 25-30 mg/L. At this concentration, recovery of product water will be limited to about 75% (if no antiscalants are used) because above this value, silica will precipitate, thus fouling the membranes. Since the KBH plant uses an antiscalant, the plant is operated at a recovery of approximately 80%, which results in a concentrate volume of about 3 million gallons per day with a silica concentration of 125 mg/L. At the present time, the concentrate is disposed of via injection wells located 23 miles from the plant.

Two different pilot-scale studies (Tarquin, A., 2005; Tarquin, A., 2006) funded by the U.S. Bureau of Reclamation and EPWU showed that it appears to be economically feasible to recover over 80% of the silica-saturated brine concentrate through lime precipitation of some of the silica. Both studies were conducted at the same pilot plant site that was used for collecting design information for the KBH plant. The feed water at that time was from one well (identified as EPWU Well No. 72). Subsequent preliminary work at the same site showed that it might be possible to recover between 80 and 90% of the RO concentrate using either vibratory shear enhanced processing (VSEP) or a seawater reverse osmosis system (SWRO). Therefore, this project was undertaken to conduct some of the same studies (i.e. lime treatment of concentrate, VSEP, and SWRO) at the KBH plant to verify that the same results could be obtained using the

actual concentrate from the full scale plant as was obtained when using Well No. 72. The results from the studies at the KBH plant are presented in this report.

## Concentrate Characterization

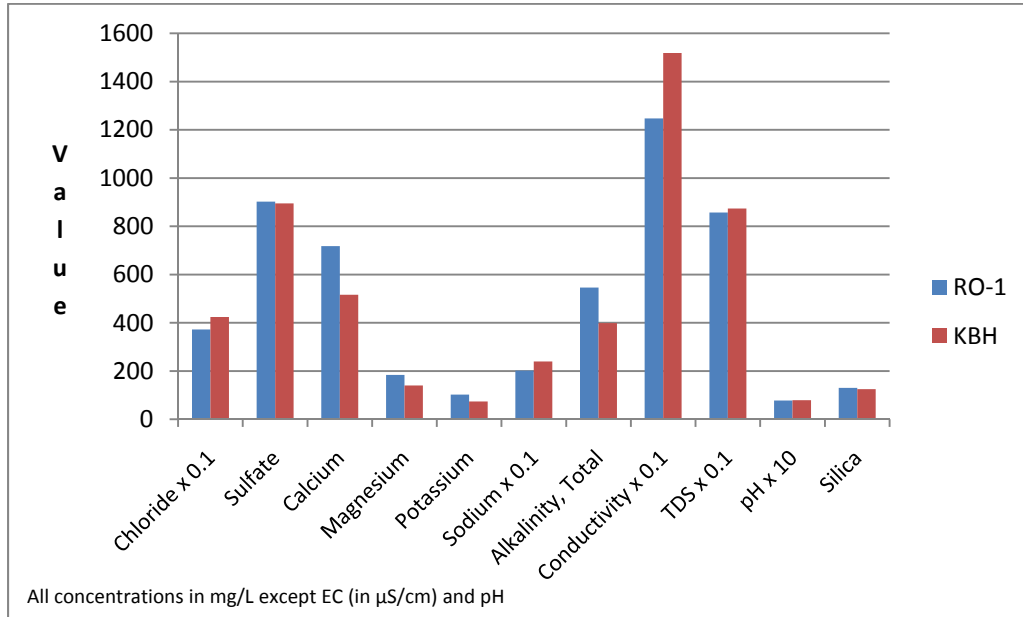
The initial studies regarding additional water recovery from RO concentrate were conducted at the original test site (i.e. Montana Booster Station) where the pilot plant was assembled for collecting data for designing the KBH plant. The feed water to that pilot plant was from only one well---Well No. 72 as shown in Figure 1.



**Figure 1. Location of Well No. 72 and Other Feed Wells**

In order to assess the extent to which the conclusions reached (regarding concentrate management) at the original pilot plant site would be transferrable to the KBH plant, the first task was to compare the characteristics of the concentrates at both sites (i.e. the concentrate from the pilot plant site, identified as RO-1 concentrate, with the concentrate from the KBH plant). Figure 2 shows the comparisons between pertinent chemical parameters of the RO concentrates from both sites. The concentrates are clearly very similar, and indeed, they have a high  $R^2$  value

of 0.93 using the least squares method. Therefore, data obtained at the pilot plant site would seem to be relevant for studies carried out at the KBH plant.



**Figure 2. Comparison of Concentrates from Pilot Plant Site and KBH Plant**

More extensive chemical characteristics of KBH concentrate are shown in Table 1. The data span the time period from September 2007 (i.e. when the KBH plant went on line) thru April 2009 and, on average, the concentrate parameters have increased by approximately 16%, based on the mean values over the period of time the plant was in operation. According to the plant superintendent, the quality of the groundwater in the feed wells has been slowly deteriorating, resulting in increased TDS in the concentrate. The change in feed water quality was expected and continues to be routinely monitored.

### Membrane Fouling Considerations

At the outset of the project, the greatest threat to membrane fouling was believed to be caused by silica. It is widely reported in the literature that at silica concentrations above about 120 mg/L, at a pH of approximately 7.0 (Neutral) and a Temperature of 65° to 75° Fahrenheit, there is a high probability that RO membranes will be fouled unless corrective actions are taken. It appears that the procedures that were followed in this project eliminated the problems associated with silica (as discussed later in this report), so other potential foulants were addressed.



Carbonate compounds are generally insoluble (defined as less than 0.01 mole/Liter), so calcium carbonate (solubility 15 mg/L at 25 °C) had to be controlled. This was done by lowering the pH of the feed solution to less than 4.0, which converts the bicarbonates to CO<sub>2</sub>.

Although most compounds of sulfate are very soluble, calcium sulfate (dihydrate solubility 2400 mg/L at 20 °C) and barium sulfate (solubility 2.4 mg/L at 20 °C) are not. Furthermore, pH has a negligible effect on the solubility of both of these compounds. This problem was dealt with by adding an antiscalant that inhibits sulfate precipitation (as discussed later in this report).

Although the antiscalant has allowed for significantly more water recovery from the concentrate, calcium sulfate still appears to be the compound that precipitates first at the high recoveries employed in the project.

**Table 1: KBH Concentrate Characteristics**

Parameter	2007			2008			2009			% Change '07-'09
	Min	Average	Max	Min	Average	Max	Min	Average	Max	
Cl	2400	4239	8890	265	4699	9710	4840	5089	5540	20.1%
SO <sub>4</sub>	453	896	1970	127	1039	2110	1050	1111	1200	23.9%
ALK-P	0	0	0	2.5	6.9	12.5	0	0	0	
ALK-T	266	424	499	18.8	412	498	400	427	445	0.6%
Ba	0.042	0.31	0.48							
B	0.028	0.11	0.17							
CL <sub>2</sub> -F	0.05	0.09	0.16	0.05	0.07	0.09				
CL <sub>2</sub> -T	0.05	0.11	0.27	0.05	0.06	0.1				
EC	1640	15185	23400	1040	16267	22100	16600	18122	20200	19.3%
Fe	0.03	0.11	0.6	0.03	0.13	0.57	0.03	0.07	0.12	-36.4%
T Hard	1180	1898	3770	528	2089	3030	2050	2291	2430	20.7%
Mn	0.09	0.17	0.23	0.1	0.16	0.21	0.11	0.17	0.22	-0.3%
ortho-P	0.1	0.16	0.27	0.1	0.16	1.26	0.11	0.19	0.49	21.4%
pH	7.5	7.9	8.1	7.1	8.0	8.3	7.6	7.8	8.0	-1.4%
Ca	303	516	1100	376	589	793	281	608	937	17.8%
K	45.5	74	114	4.9	76	99.7	43	113	759	53.4%
Mg	88.8	140	258	0.9	153	208	85.7	161	183	14.9%
Na	208	2398	4220	172	2674	4200	1730	2810	3260	17.2%
Sr	8.74	17.1	30.1							
SiO <sub>2</sub>				28.7	148	228	26.9	131	173	
TDS	6890	8738	15300	6740	10412	13200	10300	10722	11200	22.7%
CALC-TDS	1070	9867	15200	677	10566	14400	10800	11772	13100	19.3%
Temp	20.5	21.9	24	18.9	24.1	221	23.3	25.4	26.3	15.8%
Turb	0.07	0.22	1.62	0.08	0.85	14.6	0.06	0.30	1.94	34.3%

Avg = 15.5%

## Lime Treatment Laboratory Studies

One way to prevent fouling or scaling of membranes by silica is to remove the silica from the water prior to the desalting process. Lime has been shown to be very effective at removing silica (Ueda, 2003), especially after the alkalinity has been removed from the water (Tarquin, 2005). A considerable amount of research has already been conducted in El Paso relative to silica removal from RO concentrate using lime treatment. The results of that research are fully documented in two reports available from the U.S. Bureau of Reclamation (DWPR Report No. 108, Feb 2005 and DWPR Report No. 125, Mar 2006). Extensive laboratory and pilot-scale studies over a four-year period showed that lime was very effective for removing silica from RO and nanofiltration concentrates. A mathematical model was developed that allows for the prediction of silica removal as a function of lime dosage. However, all of the lime treatment studies that were conducted heretofore involved concentrate that was generated in a pilot plant that was served by a *single well* (i.e. Well No. 72). Since the KBH desalination plant is served by various combinations of 18 different wells, the purpose of this task was to conduct a lime treatment study using KBH concentrate to verify the applicability of the previously-developed predictive model for the concentrate generated at the KBH plant.

The test apparatus that was used for conducting the laboratory lime treatment evaluation was a Phipps and Bird Stirrer Model 7790-400 as shown in Figure 3. One liter of KBH concentrate was placed in each of six HACH jar test containers and various concentrations of lime were added while stirring at 50 RPM. After 30 minutes of stirring, the solids were allowed to settle for one hour before samples were withdrawn for silica analysis.



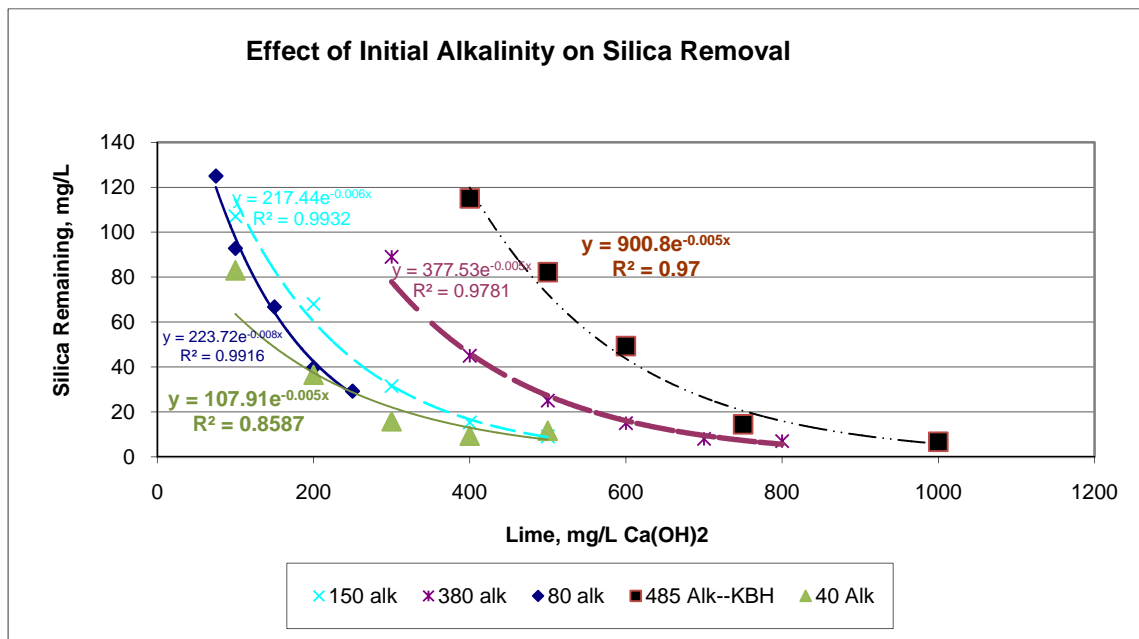
**Figure 3. Laboratory Test Set-up for Conducting Lime Treatment Studies**

Table 2 shows the silica concentrations remaining as a function of lime dosage in the KBH concentrate that had an initial alkalinity concentration of 485 mg/L as Calcium Carbonate (CaCO<sub>3</sub>). Note that there was very little silica removal until the lime dosage was high enough to remove essentially all of the alkalinity. Above a lime dosage of about 340 mg/L, a significant amount of silica removal occurs, with 43 mg/L removed (i.e. 27.2%) at a lime dosage of 400 mg/L. In fact, the results show that very low concentrations of silica are achievable through high dosages of lime.

**Table 2: Lime Treatment Results for KBH Concentrate**

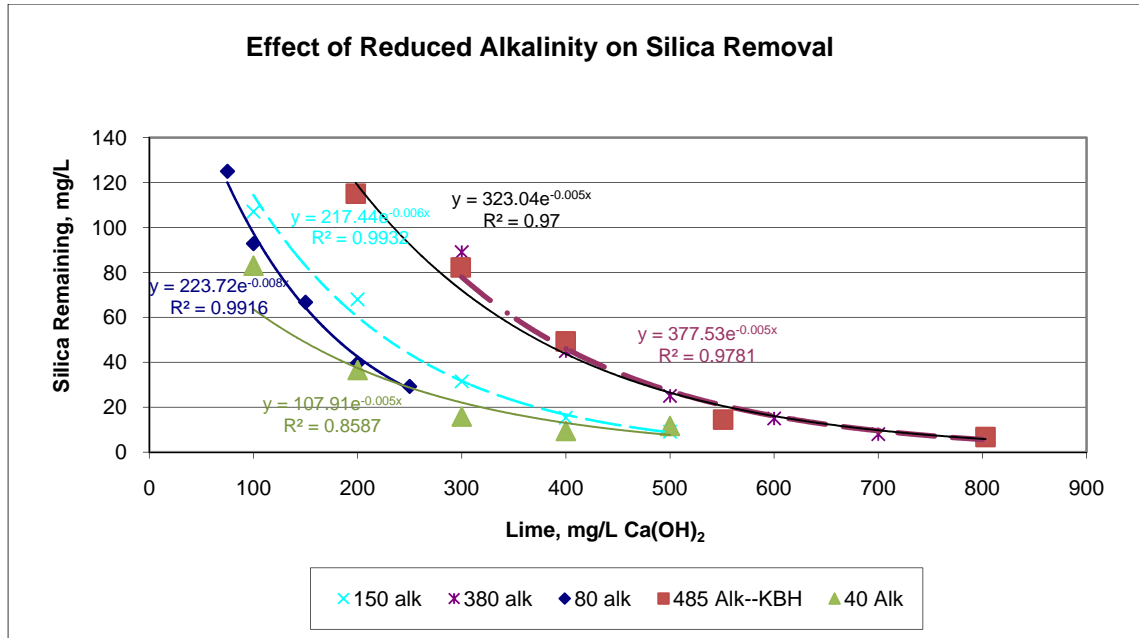
Ca(OH) <sub>2</sub> Conc, mg/L	Silica, mg/L	Alkalinity mg/L
0	158	485
200	146	485
300	140	485
400	115	485
500	82.2	485
600	49.3	485
750	14.5	485
1000	6.7	485

Figure 4 is a plot of the results obtained in the pilot study (using Well No. 72) along with the results obtained using the concentrate from the KBH plant. The pilot plant curves are the ones with initial alkalinities of 40, 80, 150, and 380 mg/L as CaCO<sub>3</sub>. The KBH curve is the one with 485 mg/L of initial alkalinity.



**Figure 4. KBH Results Plotted with Pilot Plant Results**

It is quite clear that the shapes of the curves are almost identical. In fact, when the KBH data are converted to an equivalent initial alkalinity of 380 mg/L as CaCO<sub>3</sub>, the KBH curve falls almost exactly on top of the pilot plant curve that had an initial alkalinity of 380 mg/L as CaCO<sub>3</sub> as shown in Figure 5. The correlation coefficients are greater than 0.97 and the equations are almost exactly the same. Thus, it appears that all of the lime treatment results obtained in the pilot plant studies using concentrate from Well No. 72 are dependably applicable to the concentrate generated at the KBH plant.



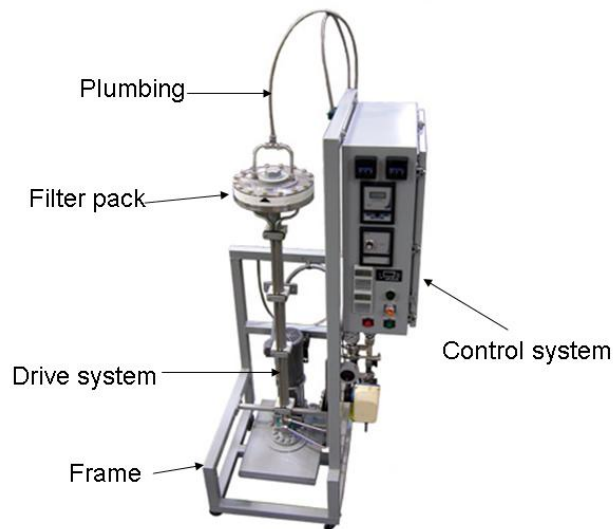
**Figure 5. KBH Results Adjusted to Alkalinity of 380 mg/L**

## VSEP Pilot Plant Studies

This section of the report presents the details of the Vibratory Shear Enhanced Processing (VSEP) pilot plant studies.

### Description of VSEP Technology

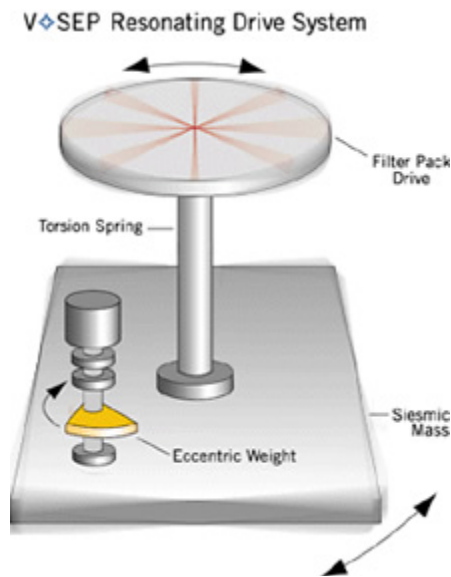
Vibratory Shear Enhanced Processing (VSEP) is a membrane treatment system utilizing vibrating membranes to produce shear waves that reduce the potential for fouling at the membrane surface. The main components of the VSEP system include a frame, drive system, plumbing, filter pack, and control system as shown in Figure 6.



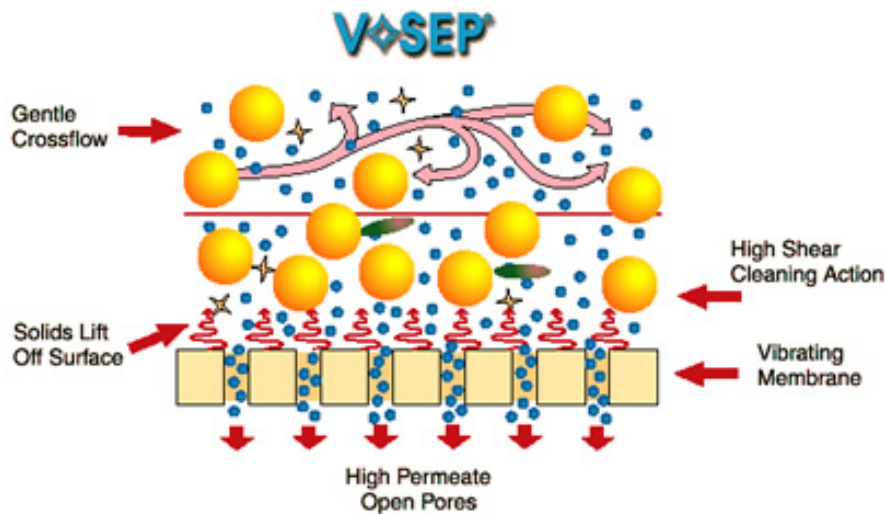
**Figure 6. VSEP Pilot Test Unit - Single Membrane (from New Logic Website)**

The heart of the system is the vibrating filter pack that consists of a series of parallel discs that contain the membranes. The disc pack is oscillated by a torsion spring connected to a seismic mass with a drive motor that produces a high rate of shear at the membrane surface, thereby reducing the potential for foulants to stick to the membrane surface, as shown schematically on Figures 7 and 8.

Various types of membranes can be used in the filter pack, ranging from microfiltration to reverse osmosis. According to the company's website ([www.VSEP.com](http://www.VSEP.com)), dewatering of slurries using microfiltration membranes were the focus of most VSEP applications, but the technology is now used in other areas, including concentrate management (Hydroscience Engineers, 2009). Typical applications include handling waters with finely divided solids, difficult-to-handle wastewaters, or high-solids applications such as bio-sludge concentration and oily-water treatment. The major advantages that VSEP technology has over conventional membrane systems are its resistance to fouling and ability to handle waters with a high solids concentration. The disadvantage appears to be the extra maintenance required for the system.



**Figure 7. Schematic of VSEP Drive System (from New Logic Website)**



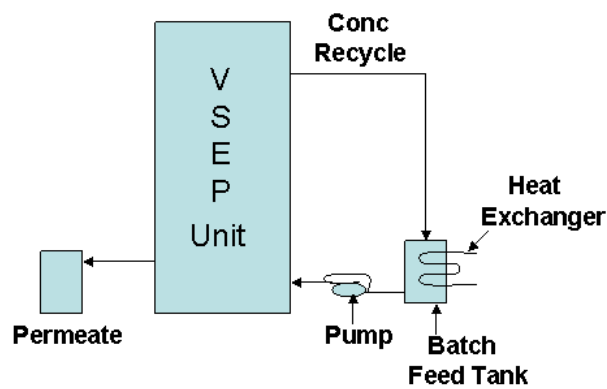
**Figure 8. Schematic of Effect of Shear at Membrane Surface (from New Logic Website)**

In September 2006, EPWU began a 4-month pilot test to evaluate the possibility of using vibratory shear enhanced processing (VSEP) technology to recover a significant amount of water from the RO concentrate without permanently fouling (i.e. scaling) the membranes with silica. The preliminary results from short-term *batch* tests (e.g. 1-2 days at each recovery) were very successful, achieving volume reductions of up to 85% with no apparent silica scaling (percent

recovery refers to the volume of permeate extracted from the batch divided by the initial batch volume). In fact, there was no precipitation of any type from the concentrate. The study period ended before any tests could be conducted at recoveries high enough to cause precipitation, a condition under which VSEP technology would work very well. Therefore, this study was undertaken to investigate the performance of a VSEP unit when suspended solids were present in the concentrate.

## VSEP Test Procedure

The test unit used in this study was a VSEP series L pilot unit that has a single membrane of 0.5 ft<sup>2</sup>. The membrane was an ESPA composite polyamide made by Hydranautics. The feed water (i.e. KBH concentrate) was placed in a 15-gallon feed tank and the pH was lowered to below 4.0 with sulfuric acid, and an antiscalant was added at 4 ppm to inhibit calcium sulfate precipitation. The concentrate was pumped at a constant pressure of 900 psi through the VSEP unit and continuously re-circulated back into the feed tank until the end of the run. Permeate was collected in a separate tank as shown schematically on Figure 9.



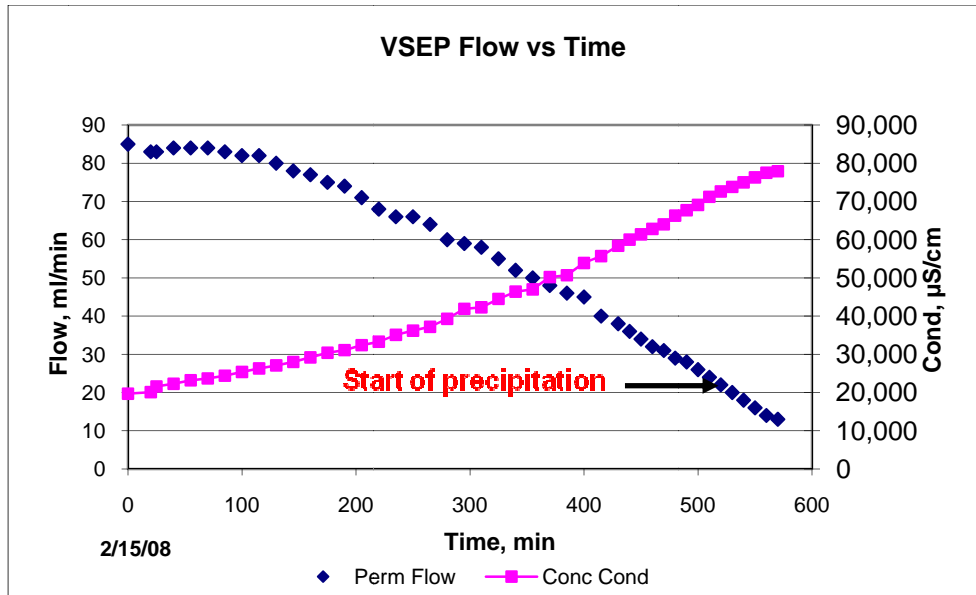
**Figure 9. VSEP Pilot Plant Test Set-up**

## VSEP Test Results

After the VSEP unit was assembled and running, a representative from the manufacturer (New Logic Research) operated the unit for the first six days of testing. During that period, usually only one batch of concentrate (at a pH just below 4.0 and containing an antiscalant to inhibit calcium sulfate precipitation) was treated each day, and the recovery was gradually increased to 75%. At this point the concentrate conductivity reached about 80,000  $\mu\text{S}/\text{cm}$  at the end of the test run. There was a precipitate present (as evidenced by cloudiness in the solution) during only one of the runs (an extra run in which the antiscalant was not added). Elemental analysis by Energy Dispersive X-ray Spectroscopy (EDAX) revealed that the precipitate was almost all calcium and sulfur with a small amount of silicone. The membrane was cleaned at the end of each run with a low pH cleaner (NLR 404) followed by a high pH cleaner (NLR 505), each for 45 minutes at approximately 40  $^{\circ}\text{C}$ . Following each cleaning, the instantaneous flux (i.e. flux at the time flow was measured) was checked using fresh water at a pressure of 500 psi, and the permeate flow rate remained at approximately 90 ml/min (flux of 68 gallons/ft<sup>2</sup>-day) during the one week test period. This indicates that there was no permanent fouling of the membrane. During all the test runs, the instantaneous permeate flow rate steadily decreased as the osmotic pressure of the concentrate increased, ending at about 10 ml/min (flux of 8 gallons/ft<sup>2</sup>-day) at the end of the run.

After the initial tests were successfully completed, the VSEP system was tested using concentrate with a precipitate present either at the beginning of a test run or at sometime after the start of a run. The results of the first run are shown in Figure 10 (the raw data are in Table A -1 in Appendix A). The conductivity of the feed solution (i.e. RO concentrate from the KBH plant) was 19,700  $\mu\text{S}/\text{cm}$  at the start of the run and it increased to almost 78,000  $\mu\text{S}/\text{cm}$  when the test was stopped after 570 minutes, at a recovery of approximately 75%. The permeate flow rate at the start of the batch test was 85 ml/min (flux of 64 gallons/ft<sup>2</sup>-day), but as the osmotic pressure of the feed solution increased, the flow rate decreased, ending at less than 13 ml/min (flux of 9.9 gallons/ft<sup>2</sup>-day) when the test was stopped. The first precipitate was evident 520 minutes into the test, when the concentrate conductivity was 72,600  $\mu\text{S}/\text{cm}$ , and by the time the test was over, the precipitate was a thick floc. The rate of change in the permeate flow rate did not appear to be affected by the precipitated solids in the feed water during the last 40 minutes of the run, as shown by the lower part of the permeate flow rate line. Even when the test was stopped, the flow rate of 13 ml/min was still a flux of almost 10 gallons/ft<sup>2</sup>-day. While most of the reduction in permeate flow rate was due to the steadily increasing osmotic pressure of the feed solution, temporary fouling could also have contributed to the decreasing flow rate.

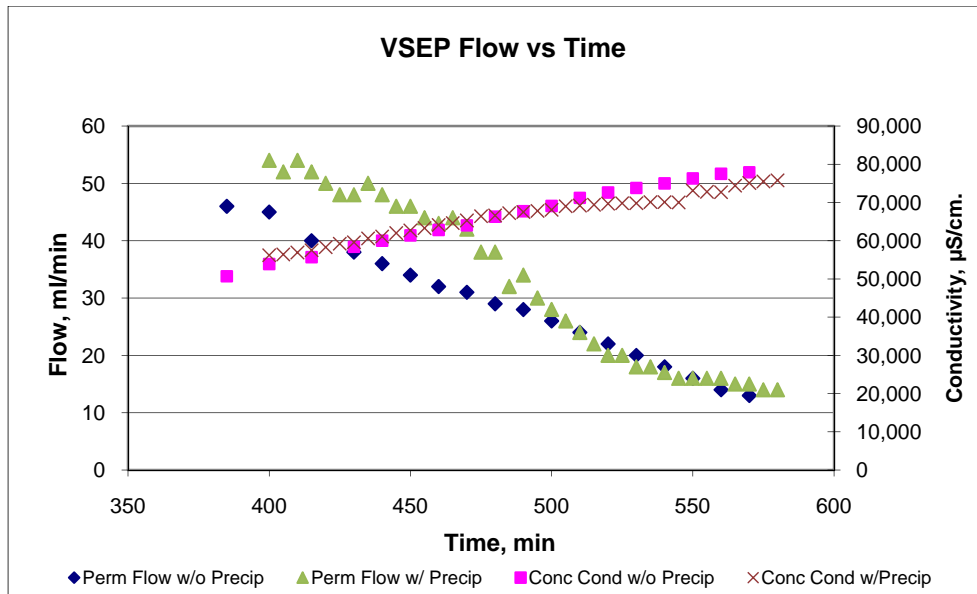




**Figure 10. VSEP Perm Flow and Concentrate Conductivity vs. Time**

The next test run used KBH RO concentrate that was concentrated to 56,000  $\mu\text{S}/\text{cm}$  using a SWRO unit without antiscalant to reduce the time required to achieve precipitation in the VSEP unit. However, precipitation was actually observed *before* the concentrate was put into the feed tank of the VSEP unit. The concentrate was transferred to the VSEP feed tank as soon as possible and the SWRO unit was immediately flushed with RO permeate to prevent fouling of the membrane. Figure 11 shows the resulting permeate flows and concentrate conductivities plotted along with the flows and conductivities from the previous run where there was no precipitate in the feed water (until near the end of the run). The raw data are shown on Table A - 2 in Appendix A.

Since the run with no precipitate was started at a feed conductivity of 19,700  $\mu\text{S}/\text{cm}$  while the run with solids was started at 56,200  $\mu\text{S}/\text{cm}$ , the data were shifted by about five hours to get the concentrate conductivities to match up before they were plotted. The higher permeate flow rates at the beginning of the run when solids were present is probably due to the fact that the membrane was recently cleaned chemically. The presence of solids in the feed water did not seem to have an effect on the permeate flow rate during this run, as shown by the similarity of the two permeate curves at similar concentrate conductivities near the middle of the run. The conductivities of the two concentrates were about the same, probably because the amount of ions precipitated from solution was small compared to the amount of ions present. Therefore, the difference was likely within the experimental error of the analysis.



**Figure 11 – Permeate Flows with and without Precipitate at Start of Run**

Other tests were conducted with the VSEP unit using solids collected from the precipitate of previous runs added to pre-concentrated KBH concentrate. In this manner, the total run times were shortened as the solids concentration in the feed water was increased. The membranes were flushed with permeate immediately after each run and in most cases, they were chemically cleaned. However, the instantaneous flow rate with fresh water (immediately after cleaning) slowly decreased as the testing progressed. Although the cleaning raised the flow rate above where it was prior to cleaning, the flow rate kept decreasing with time. By the end of the three-month pilot test period, the clean-water flow rate was about half of what it was when the testing was started. It is not known if the membrane was fouled because the cleaning protocol was not properly followed, or if it was not cleaned with the proper frequency, but the clean-water flow rate definitely indicated that fouling had taken place. Overall, VSEP technology appears to be able to handle water that contains suspended solids, but frequent cleaning may be necessary to maintain an acceptable flux.

## Seawater RO Pilot Studies

Two different seawater RO pilot units were used in this study: a small, single-membrane unit and a larger fully-automated four membrane unit. The results are presented in the next section of this report.

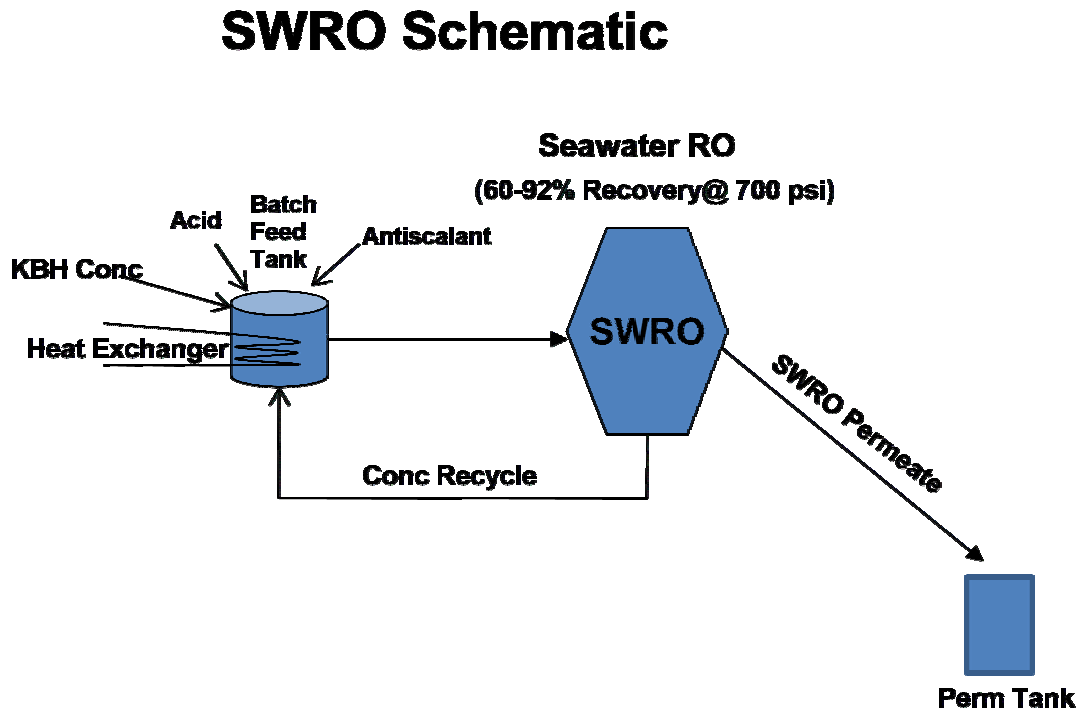
## Initial SWRO Studies with Single-Membrane Unit

The early tests conducted with the VSEP unit revealed that very high recoveries of concentrate could be achieved (i.e. up to 85%) before solids would precipitate from the solution, including silica (Unpublished data, 2007). It should be pointed out that at the time these studies were conducted, the concentrate was generated in a pilot plant that was producing relatively “weak” concentrate, exhibiting a conductivity of only about 7000  $\mu\text{S}/\text{cm}$ . Due to the success of the VSEP tests, a decision was made to test a seawater RO system, because it could be operated at pressures similar to those of a VSEP unit while requiring a lower capital investment and being much simpler to operate and maintain. For example, the bolts of the VSEP membrane housing had to be torqued at least one time per week, and a ruptured feed line, a broken clamp, and a malfunctioning feed valve required additional attention. The initial tests were conducted using a 1 gpm, 20” single-membrane unit provided by Crane Environmental as shown on Figure 12. A larger fully-automated system was built and tested (as discussed in the next section) after the results obtained using the small unit were deemed to be highly successful.



**Figure 12. Picture of Small Seawater RO Unit Used for Conducting Initial Tests**

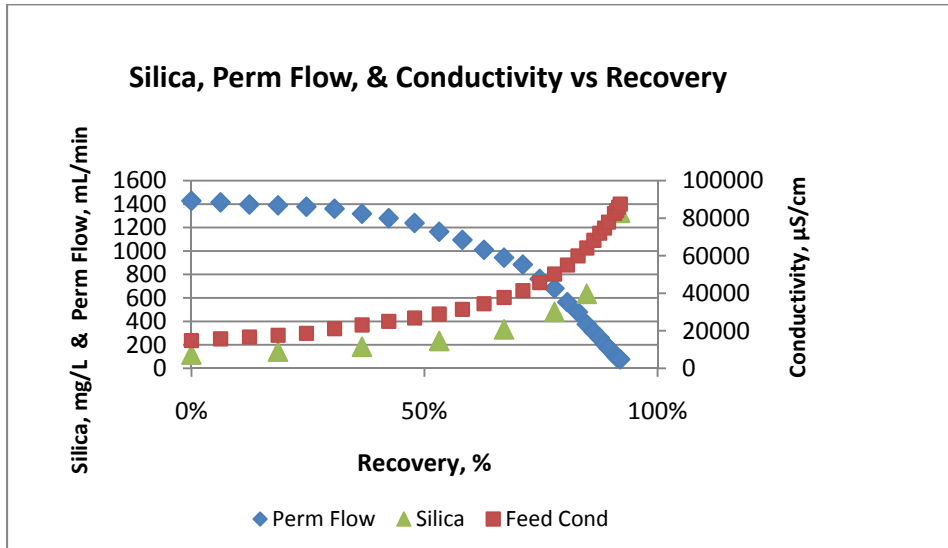
A schematic of the flow through the small SWRO test system is shown in Figure 13. Concentrate from the KBH plant was put into a 30-gallon feed tank, acid and antiscalant were added, and the solution was fed into the SWRO unit at 700 psi, with the concentrate then recycled back to the feed tank until the desired recovery was achieved. A heat exchanger kept the feed solution from overheating.



**Figure 13. Schematic of Seawater RO Test System**

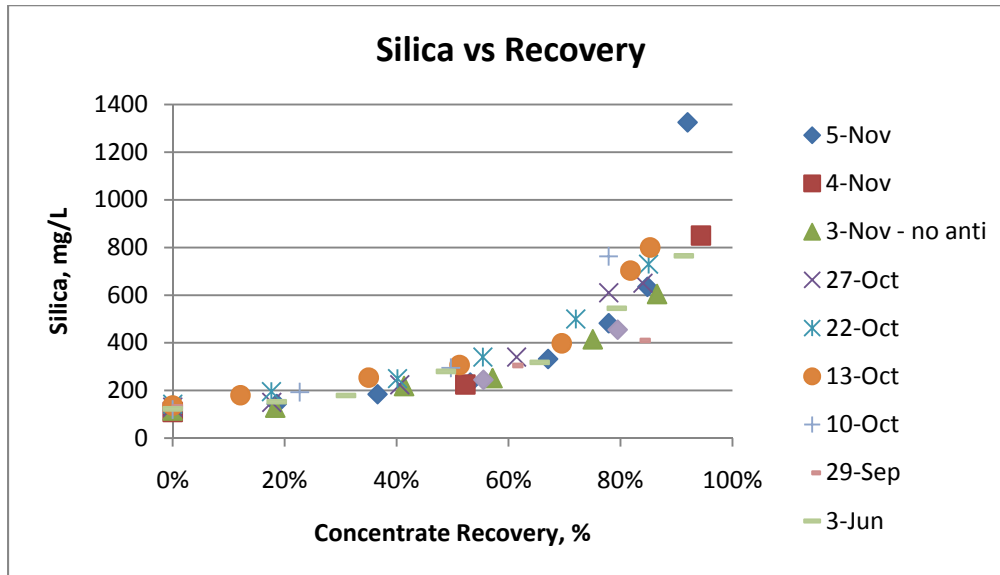
Many runs were made with the small SWRO system at recoveries ranging from 70% to 92%. The performance of the system was excellent, with no precipitation of salts until the recovery reached about 92%. Figure 14 is a plot of permeate flow, feed conductivity, and reactive silica concentration (i.e. soluble monomeric silica that is molybdate reactive and does not include colloidal or polymeric silica) versus Recovery in the feed water for a typical test run (all silica concentrations in this report are reactive silica unless noted otherwise). The decrease in permeate flow rate appears to be due solely to the increase in the osmotic pressure of the feed solution as it became more concentrated (and not due to silica precipitation or inorganic fouling), because the flow rate at the start of each new batch remained about the same as when the testing first began. The final conductivity of the feed solution was 87,000  $\mu\text{S}/\text{cm}$  at a recovery of 92%. Salt(s) began to precipitate just before the test was stopped. Scanning electron microscopy and wet chemical tests indicated that the precipitate was nearly all calcium sulfate. The silica concentration in the feed solution was over 1300 mg/L, which is more than 400 mg/L higher than any of the silica concentrations measured in previous runs. The exact reasons why such high concentrations of silica were achievable without fouling the membranes are not known with certainty, but the following four factors are likely significant contributors to the phenomenon: fast treatment of

each batch (minimizes the opportunity for silica to polymerize), reduced concentration polarization effect (due to the high cross-flow velocity and low recovery in the SWRO system), the presence of antiscalants in the concentrate (one of the antiscalants is specific for silica), and the low pH of the feed solution (some investigators believe that silica polymerization is inhibited at low pHs).

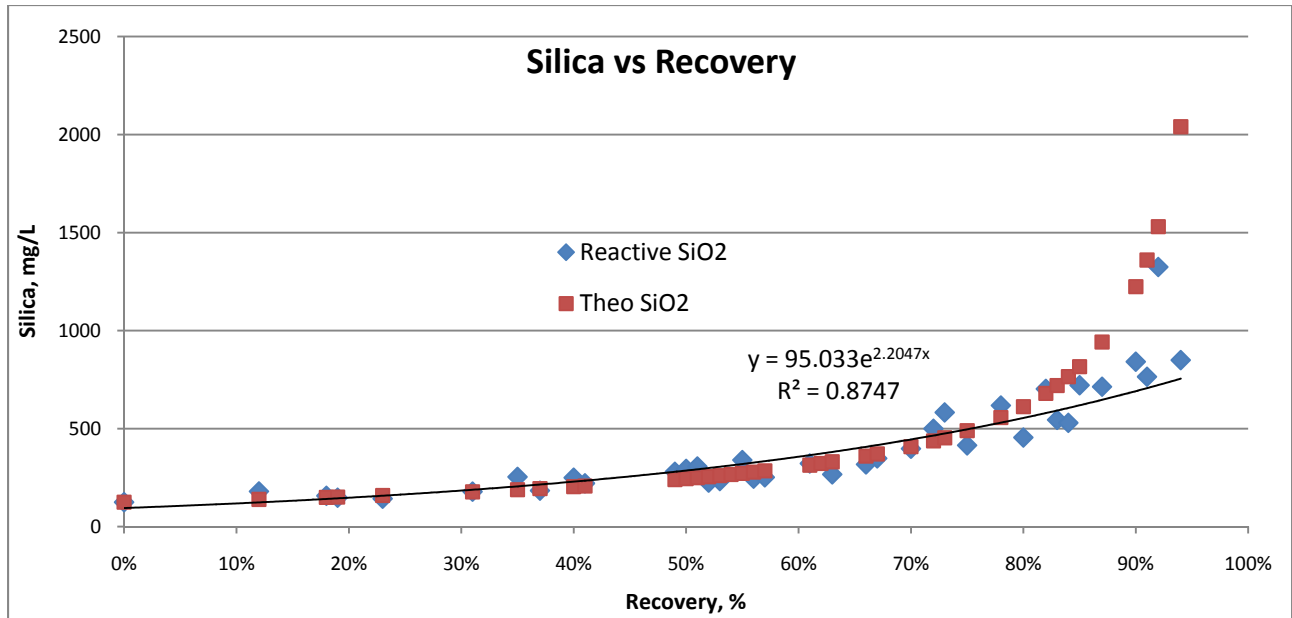


**Figure 14. Perm Flow, Silica Conc., and Feed Conductivity in Typical SWRO Run**

Figure 15 is a plot of silica concentration vs. recovery for nine different runs. The highest reading of 1325 mg/L occurred on November 5<sup>th</sup> as shown in the graph. These data were combined and plotted so that a least squares equation could be obtained as shown in Figure 16.



**Figure 15. Silica Concentration in the Feed Water of Nine Different SWRO Runs**



**Figure 16. Measured Silica Concentrations vs. Calculated Theoretical Concentrations**

The measured and calculated silica concentrations for the nine different runs are plotted in the graph and they are very close until about 80% recovery, after which the values begin to diverge. The most likely explanation is that the silica begins to polymerize at about that point, and the test that measures reactive silica (HACH molybdate assay) does not measure polymeric silica. This explanation is supported by the data in Table 3 which show the reactive silica concentrations and total silicone concentrations (expressed as silica) for one run where total silicone was measured by Inductively Coupled Plasma (ICP) Spectroscopy. The reactive and total silicone concentrations were about the same up to 80% recovery, but at 91%, the total silicone concentration was more than 26% higher than the reactive silica concentration. As stated previously, this is the recovery range where salt precipitation begins, so it is likely that approximately 90% recovery is about as far as the seawater RO process can go in recovering additional water from KBH concentrate.

**Table 3: Reactive Silica and Total Silicone (by ICP) as Silica, mg/L**

<u>Recovery</u>	<u>Reactive</u>	<u>ICP</u>	<u>% diff</u>
0	123	130	5.8%
18.6%	153	149	-2.5%
31.0%	172	179	4.0%
48.8%	225	235	4.3%
65.6%	318	328	3.2%
79.3%	525	528	0.5%
<b>91.3%</b>	<b>765</b>	<b>965</b>	<b>26.2%</b>



## Fully Automated Seawater RO System

Following the successful tests of the small SWRO unit, a larger fully automated batch-treatment system was installed and tested. A picture of the system is shown in Figure 17.



**Figure 17. Picture of Fully-Automated Batch Treatment Seawater RO System**

The system has four 4" x 40" GE-Osmonics desal membranes in a parallel single stage configuration. The concentrate feed tank and permeate collection tank are 300-gallon cone-bottom plastic tanks on metal stands. The high pressure positive displacement feed pump can discharge 32 gpm at 1200 psi and produce up to 6 gpm of permeate at the normal operating pressure of 700 psi. The system includes numerous sensors for measuring pH, permeate and concentrate flow rates, pressures, temperatures, and conductivities. The readings are data-logged at one minute intervals and stored on a computer that is accessible at all times via the internet.

Table 4 shows the characteristics of the initial KBH concentrate, the total permeate (i.e. total volume of permeate collected during the batch run), and the final concentrate, or final feed, (i.e. the concentrated concentrate that remains when the batch run is stopped) from a run that was set for 80% recovery. The TDS of the total permeate is very low at less than 200 mg/L, rendering the water very blendable. The iron concentration in the final feed is higher than it should be

based on the calculated theoretical concentration for 80% recovery, indicating that iron is being picked up somewhere in the treatment system itself (probably from within the pump, since all fittings are either stainless steel or plastic). All of the other parameter concentrations are about as expected, indicating that the system is performing as anticipated from the results obtained with the smaller SWRO pilot unit.

**Table 4: Characteristics of Initial Feed, Permeate, and Final Concentrate**

<u>Parameter</u>	<u>KBH Conc</u>	<u>Permeate</u>	<u>Final Feed</u>	<u>Theoretical Final Feed</u>
Calcium	274	<10	1432	1,370
Iron	0.14	<0.02	5.5	0.7
Magnesium	92.2	1.5	438	461
Potassium	48	<2	216	240
Sodium	1910	44.7	8640	9,550
Chloride	5520	126	26,600	27,600
Sulfate	1230	9.8	8140	8,530
Elec Cond	19,900	902	99,000	99,500
TDS	11,200	164	57,800	56,000
pH	7.8	3.2	3.6	-
Silica	126	<5	728	630

**Note 1:** All concentrations in mg/L except conductivity ( $\mu\text{S}/\text{cm}$ ) and pH (pH units)

**Note 2:** Theoretical sulfate concentration includes sulfates added in  $\text{H}_2\text{SO}_4$

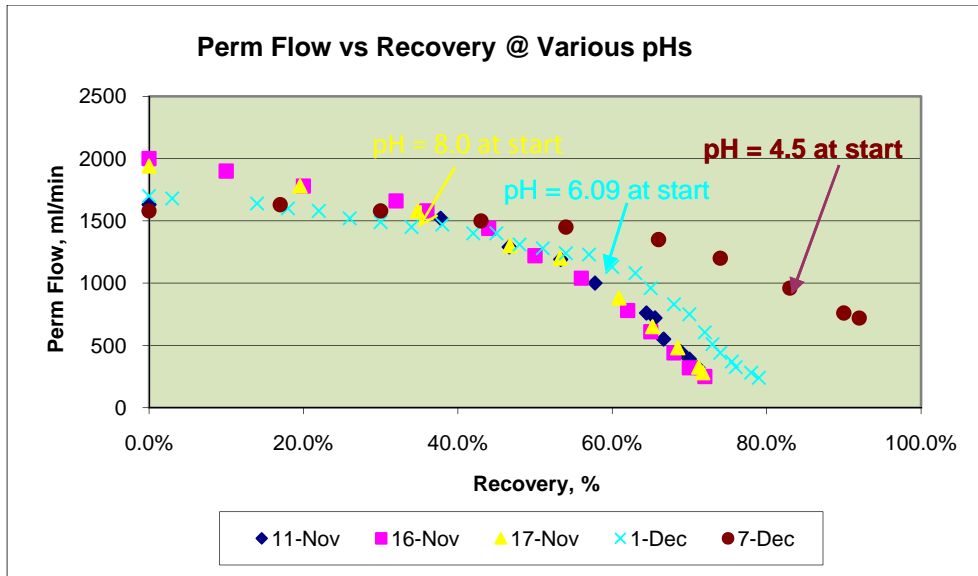
## Other Considerations

Other variables were investigated in conjunction with the VSEP and SWRO studies as discussed below, including the effect of pH on water recovery, the effectiveness of an antiscalant for inhibiting sulfate precipitation, and the effect of feed water temperature on the capital cost of the seawater system.

### Effect of pH on Recovery

In order to evaluate the effect of pH on water recovery from RO concentrate, the pH was adjusted to 8.0, 6.09, and 4.5 and fed into the VSEP unit until precipitation began. The results are shown in Figure 18.





**Figure 18. Effect of pH on Water Recovery from RO Concentrate**

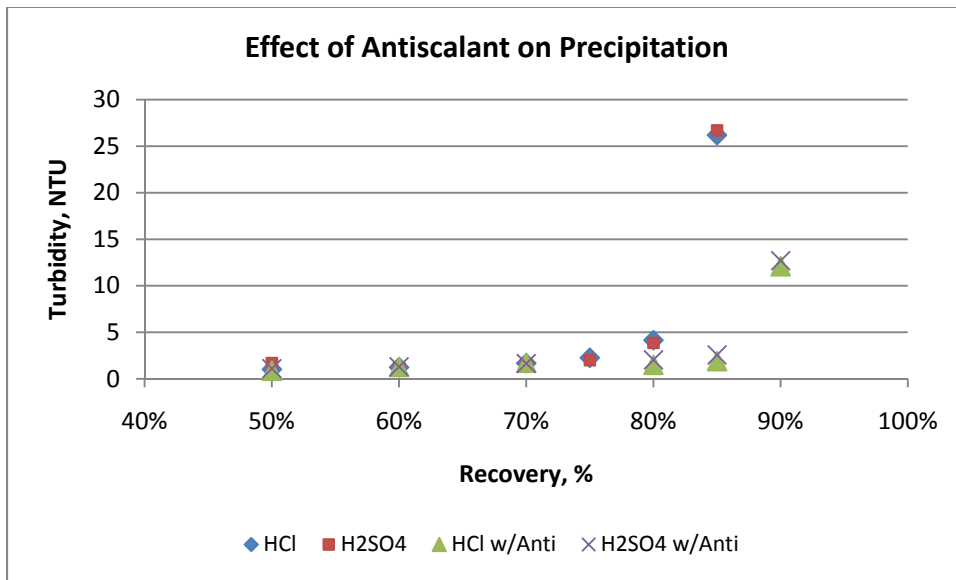
The data clearly show that as the pH was reduced, the recovery increased before precipitation occurred. An attempt was made to conduct a test run at pH 10, but precipitation occurred almost immediately, so the test was aborted. No tests were conducted on the solids precipitated from the concentrate, but it is likely that the inorganic salts, including calcium carbonate, could have reduced the permeate flow. On the basis of these results, most of the subsequent tests were conducted at pHs' below 4.5.

### Antiscalant and Acid Evaluation

In conventional membrane processes, water recovery from brackish water solutions is limited by precipitation of the least soluble salt. In the case of KBH concentrate, EDAX analysis of the solids that precipitated from highly concentrated RO concentrate revealed that the solids were primarily calcium sulfate. The seawater RO process that was used in this study required that the pH of the feed solution be reduced from about 8.0 to below 4.0. Two commonly used acids for doing so are hydrochloric and sulfuric. Hydrochloric acid has the advantage of not adding sulfates to the treated water, but it is harder to handle (because of its tendency to fume) and it is only one third the strength of sulfuric acid. Conversely, sulfuric acid does not fume and is less expensive than hydrochloric acid. In order to determine if the type of acid used to lower the pH would significantly affect the point where calcium sulfate precipitation would occur, laboratory tests were conducted in two-liter beakers wherein the recovery was simulated using KBH concentrates that were treated with each type of acid. Various amounts of calcium chloride and sodium sulfate were added to each of the beakers containing the vigorously-stirred solutions of acid-treated KBH concentrate and then checked for salt precipitation by measuring the turbidity of the solutions. In addition to evaluating the effect of acid type on calcium sulfate precipitation, an antiscalant intended to inhibit calcium sulfate precipitation was also tested. The antiscalant

was added at 4 ppm to two samples of KBH concentrate that had the pH reduced to 3.5, one with sulfuric and the other with hydrochloric acid.

The results of the tests are plotted in Figure 19. The graph shows that precipitation occurred at approximately 80% recovery in each of the acid-only solutions, based on a spike in turbidity. The law of mass action dictates that the solution having the higher sulfate concentration should precipitate first, but the 5% increments in recovery that were utilized in the testing protocol were apparently not precise enough to detect the difference in precipitation points. In any case, for our purposes, the advantages that sulfuric acid has over hydrochloric acid (including a huge cost differential) would favor using sulfuric acid for reducing the pH of the feed solution.



**Figure 19. Effect of Acids and Antiscalant on Calcium Sulfate Precipitation**

When the antiscalant was added in addition to the acid, the results show that the antiscalant did indeed allow for more recovery of water from the concentrate before precipitation began. Regardless of which acid was used in pre-treating the concentrate, precipitation did not occur until a recovery of about 86% was achieved. The difference between 80 % and 86% recovery represents only a 6% increase in recovery of water, but perhaps more significantly for inland systems, it represents a 30% reduction in the volume requiring final disposal. This would obviously have a meaningful impact on the cost of concentrate management when evaporation is used for disposal of the final concentrate. Thus, the use of the antiscalant for inhibiting calcium sulfate precipitation in the KBH concentrate appears to well founded.

In addition to the lab-scale testing of the effectiveness of the antiscalant, comparative tests were conducted at the pilot plant site by running KBH concentrate through both the VSEP and the seawater RO units with and without antiscalant treatment. The pilot scale results showed that more water could be extracted from the concentrate when using the antiscalant. That is, without

the antiscalant, precipitation generally occurred at conductivities below 64,000  $\mu\text{S}/\text{cm}$ , which corresponds to a recovery of between 70% and 85%, depending on the strength of the concentrate at the beginning of the test. When the antiscalant was used, concentrate conductivities of over 75,000  $\mu\text{S}/\text{cm}$  were attained without precipitating anything from the feed solution (in one test, the conductivity of the final concentrate was over 86,000  $\mu\text{S}/\text{cm}$ ). Thus, the pilot scale results confirmed the laboratory tests, demonstrating that the antiscalant was very effective at inhibiting calcium sulfate precipitation.

## **Feed Water Temperature vs. Capital Cost**

All membrane systems are affected by feed water temperature because the viscosity of water is a function of temperature. As the temperature goes up, the viscosity goes down, so the flux increases. The higher the flux, the lower the capital cost for a given permeate production rate. For purposes of this discussion, the calculations will be based on a permeate flow rate of one MGD, the capital cost for a seawater RO system will be assumed to be \$700,000 per MGD (Industrial Water Systems, Inc, 2009), and a temperature change of 10  $^{\circ}\text{C}$  (say from 25 to 35  $^{\circ}\text{C}$ ) will be evaluated. Temperature correction factors by APS Water Services for thin film composites are used in these calculations. The temperature correction factor (TCF) for 25  $^{\circ}\text{C}$  water is 1.00 and for 35  $^{\circ}\text{C}$  water is 0.73. This means that the capital cost for a system treating the higher temperature water will be 27% less than the base system, or \$511,000 per MGD, for a savings of \$189,000 per year.

The amount of energy required to raise the temperature of one MGD by 10  $^{\circ}\text{C}$  (18  $^{\circ}\text{F}$ ) is 150,120,000 BTUs. If it is assumed that the water will be heated by natural gas that costs \$5 per million BTUs, the cost per day will be \$750.60, or \$273,969 per year (assuming 100% heat transfer efficiency). This extra cost for one year is greater than the entire savings in the capital cost of the SWRO system, so it clearly would not be cost effective to heat the water with natural gas. If some type of solar energy heating system were to be used, the annualized capital and operating costs would have to have a present worth of \$189,000 for breakeven, and this seems to represent an unlikely scenario. Thus, unless heat energy were available for free or at a very low cost, it does not appear to be economically attractive to heat the feed water prior to treatment in an SWRO system.

## **Economic Considerations**

In considering the economics of the batch-treatment SWRO concentrate recovery process, the values used in the calculations are, at best, reflective of the costs at a certain place and at a given point in time. Nevertheless, similar projects at other locales would have much in common with this project, so the cost estimates obtained here should represent a good guide as to what to

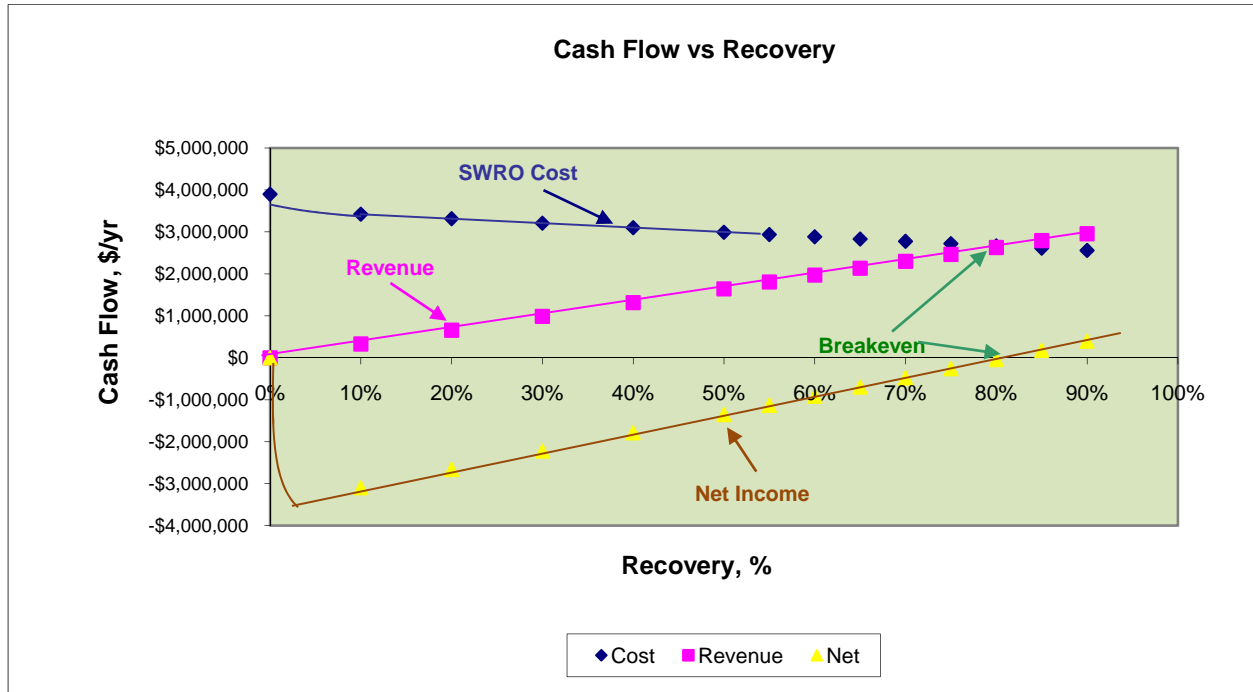
expect in similar projects at other places, especially after prudent adjustments for time and place have been made. The calculations that follow do not include VSEP technology because the preliminary capital cost at \$80 per ft<sup>2</sup> of membrane is more than 11 times the cost of a seawater RO system. The cost of VSEP membranes at \$45 per ft<sup>2</sup> is also more than 10 times the cost of a seawater RO membrane. Thus, even if the flux in a VSEP unit were two or three times greater than that in a SWRO unit (which is unlikely for concentrate that does not contain suspended solids), the cost for VSEP technology would be considerably greater than that for a conventional seawater RO system.

The values associated with the parameters used in deriving the costs for a full-scale project are shown in Table 5. The \$2.00/1000 gallon selling price for water represents the approximate cost of water in the first tier of EPWU's water rate structure. This represents a conservative (i.e. low) estimate of income because a substantial amount of water is sold at higher prices, especially in the summer months. Cost-related components that are not included in this project but may have to be included in projects considered elsewhere are land costs, pipeline costs, and solids disposal costs. These components are not included herein because of circumstances that may be unique to this project, but their impact on total costs will be discussed below.

**Table 5: Values Used in Calculating Cost of Water Recovered From RO Concentrate**

<u>Item</u>	<u>Value</u>
Initial RO conc volume (gpd)	3,000,000
Interest rate (%)	5%
Evap rate (in/yr)	50
Liner cost, \$/sq ft	0.60
Liner life, yrs	20
Excavation, \$/cu yd	\$3.00
Fence, \$/LF	\$10.00
Flow storage, mos	6
Excavation & fence amortztn time, yrs	20
Equipment life, yrs	20
Water selling price,\$/1000 gal	\$2.00
Blending well depth, ft	300
Blending ratio (total vol/RO perm)	1.5
SWRO membrane life	5
RO capital cost, \$/MGD	\$700,000
Power cost, \$/kw-hr	\$0.08
Pump & Motor efficiency, %	75%
Buildings, \$	\$320,000
RO membrane cost, \$/ sq ft	\$2.00
SWRO flux,gpd/sq ft	15
SWRO operating pressure, psi	700
Antiscalant, \$/9 lb gallon	\$11
H <sub>2</sub> SO <sub>4</sub> , \$/gal	\$2.53
H <sub>2</sub> SO <sub>4</sub> feed rate, ml/gal	1.0
Personnel cost, \$/yr 6@\$35,000	\$210,000
Contingencies, \$/yr	\$200,000

The results of the cost calculations as a function of water recovery are shown in Figure 20. The breakeven point occurs at a recovery a little above 80%. At recoveries above the breakeven point, there is positive cash flow to the Utility.



**Figure 20. SWRO Costs and Cash Flow vs. Water Recovery**

The values associated with the various recoveries are shown in Table 6. At a recovery of 85% (which has been shown to be feasible for this project), the cost of the recovered water would be \$1.87 per thousand gallons and the Utility would have a positive cash flow of \$178,000 per year. The net positive cash flow at 90% would be over \$400,000 per year. Inclusion of items that were not considered here such as land cost would add about \$0.05 per thousand gallons of product water for each \$1 million of capital cost.

In addition to the positive cash flows associated with the project, there would be an extra 3.8 MGD of drinking water produced from the RO concentrate that would otherwise be thrown away (at additional cost). Thus, a batch-treatment seawater reverse osmosis system for recovering water from the RO concentrate at the KBH Desalination plant appears to be very attractive from an economic point of view, but many other factors would have to be taken into consideration when evaluating whether or not to move forward in implementing a full-scale project.

**Table 6: Product Water Costs as a Function of Percent Recovery**

Recovery, %	Product Water Cost, \$/1000 gal	Net Revenue, \$/yr
0		0
10%	\$22.50	-\$3,367,933
20%	\$10.81	-\$2,895,492
30%	\$6.92	-\$2,422,983
40%	\$4.97	-\$1,950,393
50%	\$3.80	-\$1,477,701
55%	\$3.37	-\$1,241,306
60%	\$3.02	-\$1,004,872
65%	\$2.72	-\$768,391
70%	\$2.46	-\$531,852
75%	\$2.24	-\$295,240
80%	\$2.04	-\$58,532
85%	\$1.87	\$178,311
90%	\$1.72	\$415,365

## Conclusions

Based on the results obtained in this investigation, the following conclusions can be made with reasonable certainty:

1. A batch-treatment seawater RO system is very effective for recovering most of the water (i.e. 85 – 90%) from the concentrate of the brackish groundwater reverse osmosis treatment system at the KBH desalting plant in El Paso, TX.
2. With proper pH control and antiscalant dosage, a batch-treatment SWRO system can be used to recovery water from silica-saturated RO concentrate without fouling the membranes. Silica concentrations of over 1000 mg/L are attainable with relatively minimal pre-treatment of the silica-saturated feed solution.
3. VSEP technology can be used to recover water from silica-saturated RO concentrate, but a SWRO system is much more attractive from a capital cost and system-maintenance point of view. However, a VSEP system is able to recover some water from RO concentrate that contains precipitated salts.
4. Lime is very effective for removing silica from RO concentrates after the lime demand from carbonate and bicarbonate alkalinity has been satisfied.

5. The antiscalant that was added for suppressing sulfate precipitation was very effective, allowing for the recovery to be increased from 80% to 86% before precipitation began.
6. A full-scale batch treatment seawater RO system for treating RO concentrate from the KBH desalting plant would yield about four million gallons of product water per day (after blending) at a cost of \$1.87 per thousand gallons.

## Recommendations

The successes achieved in this study can be enhanced by carrying out the following recommendations:

1. The batch treatment system that was employed in this study was shown to perform very well, delivering water recovery in the 85 – 90% range. If the same level of recovery could be achieved when operating in a *continuous flow mode*, the system would probably have a lower capital cost and be easier to operate than the batch-treatment system. A project should be undertaken that would involve constructing and evaluating an automated, continuous flow SWRO system for recovering water from the silica-saturated RO concentrate.
2. An antiscalant dosage of 4 ppm was used to control calcium sulfate precipitation in this study. Since no other dosages were tested in this study, it is unlikely that 4 ppm is the optimal dosage that should be used. A study should be conducted to determine the dosage of antiscalant that would yield the lowest unit water cost and highest net income.
3. This project was carried out using RO concentrate that was generated at the KBH plant in El Paso, TX. Projects similar to this one should be conducted in other locales to determine the extent to which the results obtained here are applicable to RO concentrates that have different chemical make-ups than the one used in this study.
4. It is known that several factors affect the stability or precipitation of silica in RO concentrates. A study should be conducted to determine which factors have the greatest effect on silica precipitation from membrane concentrates.

## References

1. Tarquin, A., “Volume Reduction of High-Silica RO Concentrate Using Membranes and Lime Treatment”, U.S. Department of the Interior, Bureau of Reclamation, DWPR Report No. 108, Feb 2005.
2. Tarquin, A., “Cost Effective Volume Reduction of Silica-Saturated RO Concentrate”, U.S. Department of the Interior, Bureau of Reclamation, DWPR Report No. 125, Mar 2006.
3. Ueda, Akira, “Silica Removal from Mokai, New Zealand, Geothermal Brine by Treatment with Lime and a Cationic Precipitant”, Geothermics, V32, Issue 1, Feb 2003, 47-61.
4. Industrial Water Systems, Inc., Personal Communication, Apr 2009.
5. APS Water Services, APS TechNotes, “Reverse Osmosis Systems Flow Rate Changes With Temperature”, [www.apswater.com/article](http://www.apswater.com/article).
6. Hydrosience Engineers, Award for Cache Creek Desalination Facility, WaterReuse Association Symposium, Seattle, WA, Sept 13-16, 2009.
7. Unpublished data, collected by Anthony Tarquin for El Paso Water Utilities, (Sept 2006 – February 2007)



# Appendix A

**Table A-1: VSEP Test Results with Antiscalant (2/15/08)**

<u>Time,</u> <u>min</u>	<u>Flow,</u> <u>ml/min</u>	<u>Conc Cond</u>	<u>pH</u>
0	85	19,700	3.30
20	83	20,100	3.31
25	83	21,600	3.32
40	84	22,300	3.35
55	84	23,200	3.38
70	84	23,700	3.40
85	83	24,400	3.42
100	82	25,400	3.45
115	82	26,300	3.50
130	80	27,100	3.52
145	78	28,000	3.57
160	77	29,200	3.60
175	75	30,400	3.64
190	74	31,100	3.69
205	71	32,400	3.72
220	68	33,300	3.76
235	66	35,100	3.81
250	66	36,200	3.84
265	64	37,200	3.88
280	60	39,300	3.95
295	59	41,900	3.99
310	58	42,300	4.02
325	55	44,500	4.08
340	52	46,400	4.13
355	50	47,000	4.18
370	48	50,200	4.22
385	46	50,700	4.25
400	45	53,900	4.28
415	40	55,700	4.31
430	38	58,400	4.37
440	36	60,000	4.39
450	34	61,400	4.40
460	32	62,800	4.41
470	31	64,000	4.43
480	29	66,300	4.48
490	28	67,700	4.50
500	26	69,100	4.53
510	24	71,200	4.57
520	22	72,600	4.60
530	20	73,800	4.64
540	18	75,000	4.69
550	16	76,300	4.74

**silica = 660, 730 mg/L**

slight turb. evident in conc

definite turbidity

Turbid,

560	14	77,500	4.79	nice floc; can't see stirrer
570	13	77,900	4.84	

**Table A-2: VSEP Test Results with Precipitation at Start**

**Note: Conc had already precipitated in SWRO before it was put in VSEP feed tank**

<u>2/29/2008</u>				
<u>Time,min</u>	<u>Pressure</u>	<u>Flow, ml/L</u>	<u>Conc Cond</u>	<u>pH</u>
0	900	54	56200	5.07
5	900	52	56400	5.13
10	900	54	56900	5.26
15	900	52	57500	5.35
20	900	50	58300	5.47
25	900	48	59200	5.54
30	900	48	59600	5.63
35	900	50	60600	5.68
40	900	48	61100	5.73
45	900	46	62000	5.76
50	900	46	62700	5.78
55	900	44	63300	5.79
60	900	43	64100	5.79
65	900	44	64600	5.79
70	900	42	65300	5.79
75	900	38	66400	5.77
80	900	38	66600	5.76
85	900	32	67200	5.76
90	900	34	67500	5.75
95	900	30	67800	5.73
100	900	28	68100	5.73
105	900	26	69000	5.72
110	900	24	69200	5.71
115	900	22	69400	5.72
120	900	20	69700	5.72
125	900	20	69800	5.72
130	900	18	69800	5.72
135	900	18	70100	5.73
140	900	17	70100	5.73
145	900	16	70000	5.73
150	900	16	73100	5.72
155	900	16	72800	5.74
160	900	16	72700	5.73
165	900	15	74400	5.72
170	900	15	75100	5.73
175	900	14	75500	5.74
180	900	14	75800	5.74

## **Acknowledgements**

This project could not have been undertaken without the financial support received from the Texas Water Development Board and El Paso Water Utilities. Many individuals within the Utility were involved in constructing and maintaining the equipment used in this project, but special recognition goes to Ralph Padilla for his unending willingness to contribute to the success of this project in every way.